



STEELER

SOKÓŁKA

www.steeler.pl

NISSAN QASHQAI 2017



INSTRUKCJA MONTAŻU

(Orurowania przednie niskie)

FITTING INSTRUCTION

(Front bullbar)

Инструкция монтажа

(Кенгурин)

MONTAGEANLEITUNG

(Frontschutzbügel)

QUA-R1770-06



Orurowania z homologacją „e”

Bullbar with homologation „e”

Тюнинг с омологацией „e”



Frontschutzbügel mit „e“- Prüfzeichen

Wykaz elementów orurowania:

Specification of full assembly:

Список элементов тюнинга:

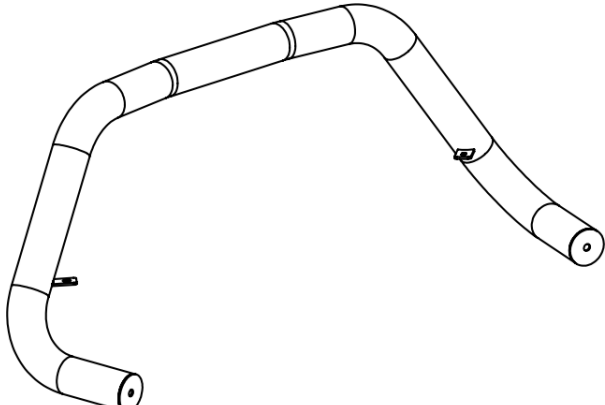
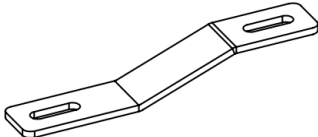
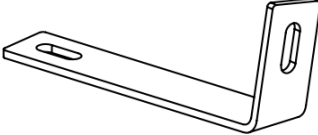
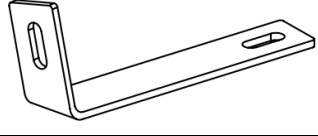
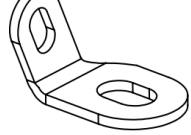
Liste der Elemente:

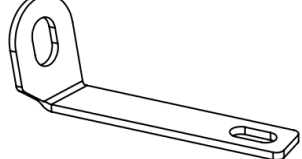
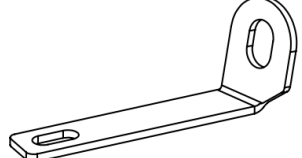
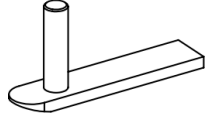
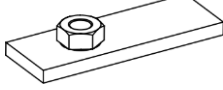
<p>1. Rura przednia (szt. 1) Bullbar (1 pc.) Передняя дуга (шт.1) Frontbügel (st.1)</p>	
<p>2. Zamocowanie górne I (szt.2) Upper attachment I (2 pcs.) Крепление верхнее I (шт.2) Montage oben I (st.2)</p>	
<p>3. Zamocowanie górne lewe II (szt.1) Upper left attachment II (1 pc.) Крепление верхнее левое II (шт.1) Montage oben links II (st.1)</p>	
<p>4. Zamocowanie górne prawe II (szt.1) Upper right attachment II (1 pc.) Крепление верхнее правое II (шт.1) Montage oben rechts II (st.1)</p>	
<p>5. Zamocowanie dolne lewe I (szt. 1) Lower left attachment I (1 pc.) Крепление нижнее левое I (шт.1) Montage unten links I (st.1)</p>	
<p>6. Zamocowanie dolne prawe I (szt. 1) Lower right attachment I (1 pc.) Крепление нижнее правое I (шт.1) Montage unten rechts I (st.1)</p>	
<p>7. Zamocowanie dolne lewe II (szt. 1) Lower left attachment II (1 pc.) Крепление нижнее левое II (шт.1) Montage unten links II (st.1)</p>	
<p>8. Zamocowanie dolne prawe II (szt. 1) Lower right attachment II (1 pc.) Крепление нижнее правое II (шт.1) Montage unten rechts II (st.1)</p>	
<p>9. Szpilka M8x30 (szt. 2) Skewer M8x30 (2 pcs.) Шпилька M8x30 (шт.2) Stecknadel M8x30 (st.2)</p>	
<p>10. Zamocowanie dolne III (szt. 2) Lower attachment III (2 pcs.) Крепление нижнее III (шт.2) Montage unten III (st.2)</p>	

Wykaz elementów łącznych:
Connecting components:
Список соединительных элементов:
Die Auflistung der Elemente:

Śruby (szt.) Screws (pcs.) Болты (шт.) Schrauben (st.)	M8x25 – (4) M8x30 – (2) (szpilka - skewer) M10x35 – (4) M12x35 – (2)	Nakrętki (szt.) Nuts (pcs.) Гайки (шт.) Muttern (st.)	M8 – (6) M10 – (2)
Podkładki (szt.) Washers (pcs.) Шайбы (шт.) Unterlegscheiben(st.)	Ø 8 – (10) Ø 8 – (6) – SPR Ø 10 – (6) – XL Ø 10 – (4) – SPR Ø 12 – (2) – XL Ø 12 – (2) – SPR		

M6 - 7 Nm	M8 - 17 Nm	M10 - 33 Nm	M12 - 57 Nm
-----------	------------	-------------	-------------

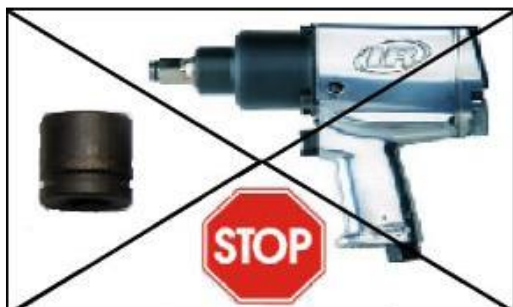

1 h

Czas montażu
Fitting time
Время монтажа
Montagezeit

UWAGA: Folię usunąć dopiero po montażu!

ATTENTION: Foil remove after fitting!

ВНИМАНИЕ: Целлофан снять только после завершения монтажа!

HINWEIS: Die Folie soll erst nach der Montage entfernt werden!

Montaż orurowania / Bullbar fitting / Монтаж защиты / Montage der Schwellerrohre
QUA-R1770-06

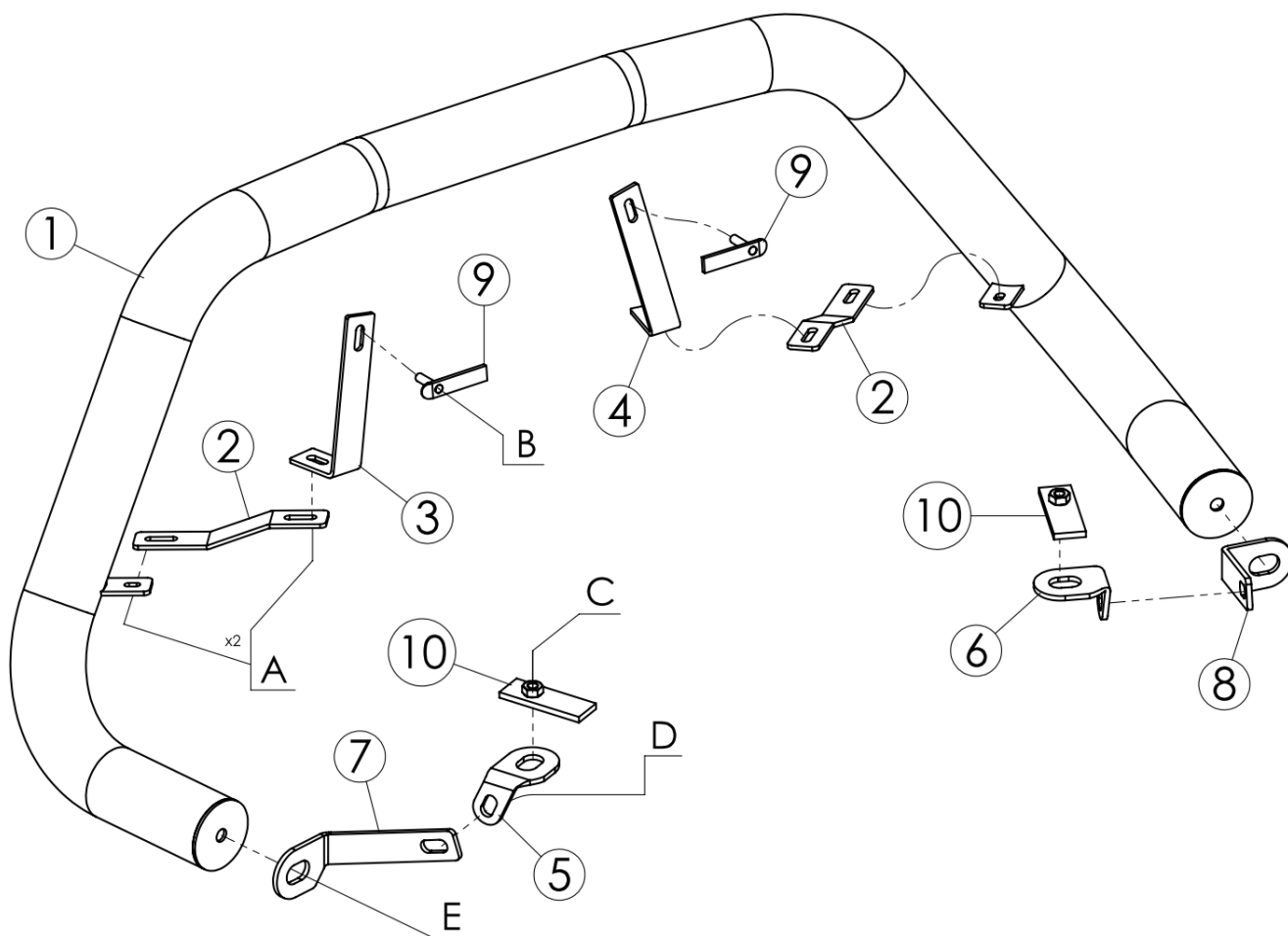

9,5 kg

	Śruby (szt.) Screws (pcs.) Болты (шт.) Schrauben (st.)	Podkładki (szt.) Washers (pcs.) Шайбы (шт.) Unterlegscheiben (st.)	Nakrętki (szt.) Nuts (pcs.) Гайки (шт.) Muttern (st.)
A	<i>M8x25</i>	<i>Ø8(x2)</i> <i>Ø8-SPR</i>	<i>M8</i>
B	<i>M8x30</i>	<i>Ø8</i> <i>Ø8-SPR</i>	<i>M8</i>
C	<i>M10x35</i>	<i>Ø10-SPR</i> <i>Ø10-XL</i>	-----
D	<i>M10x35</i>	<i>Ø10-SPR</i> <i>Ø10-XL(x2)</i>	<i>M10</i>
E	<i>M12x35</i>	<i>Ø12-SPR</i> <i>Ø12-XL</i>	-----

B – szpilka / skewer/ шпилька/ Stecknadel

Lewa górną część orurowania / Left upper attachments / Левая, верхняя часть защиты / Linke, obere Seite des Frontschutzbügels



13

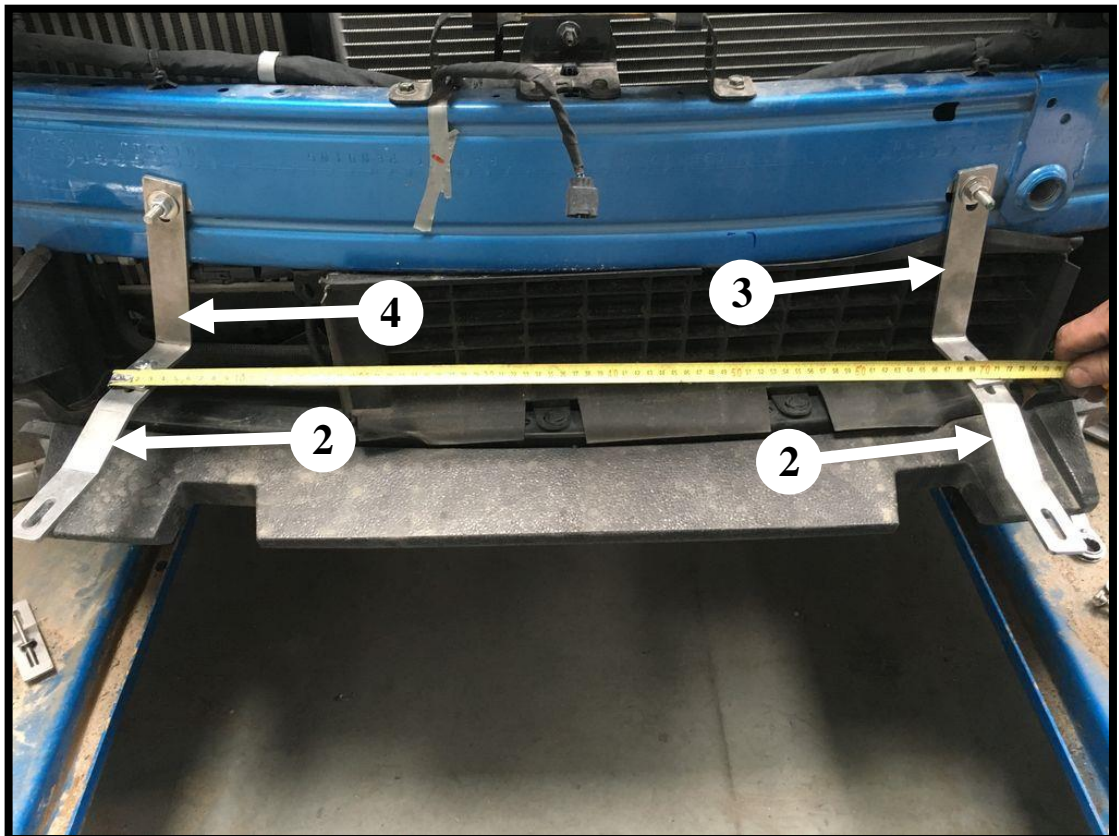
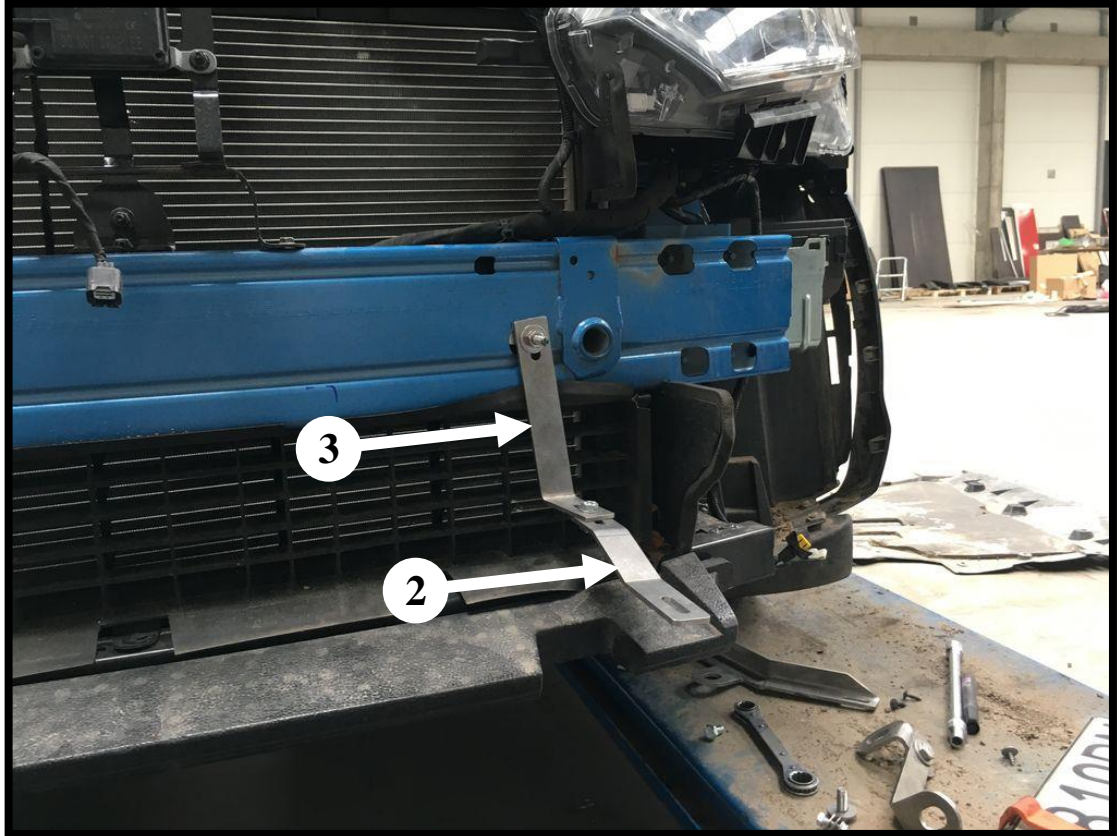

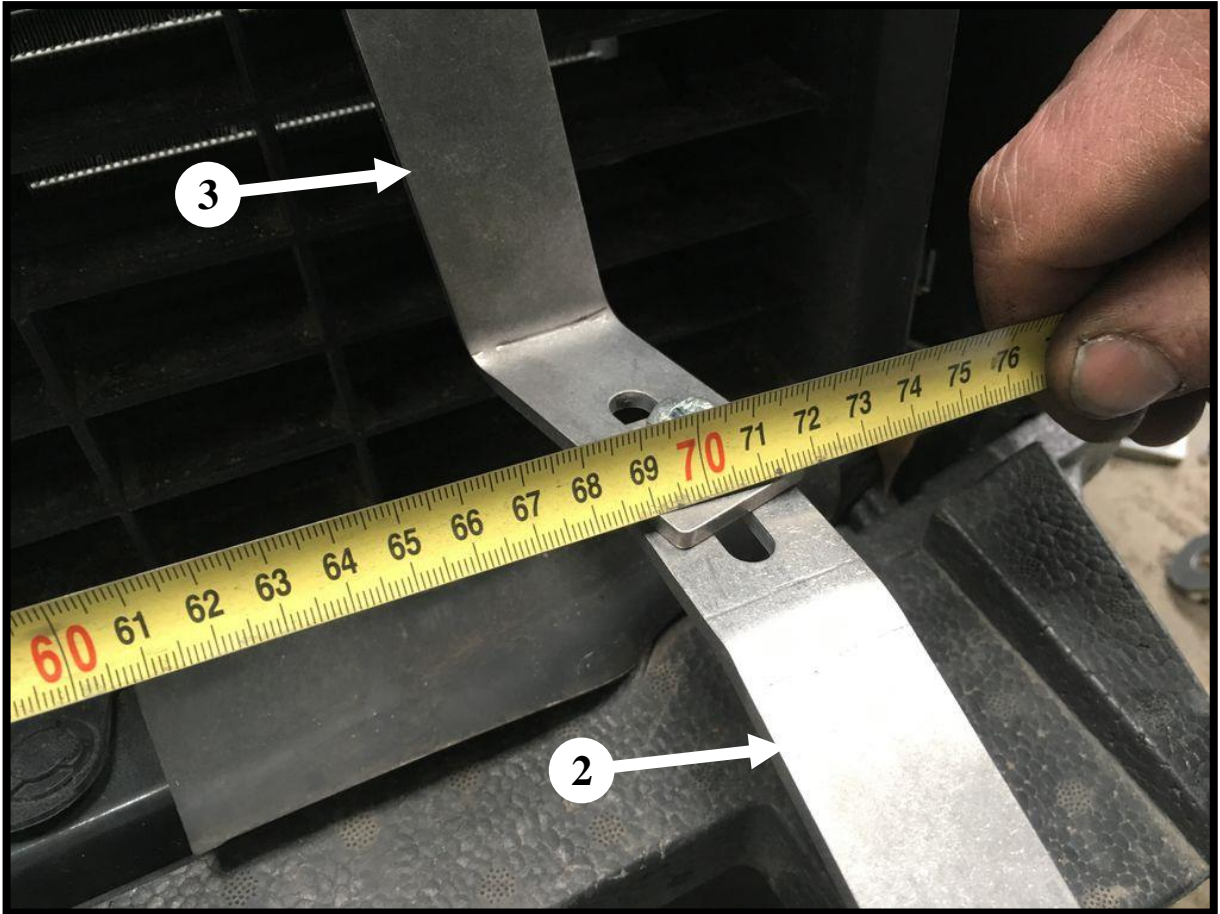

Prawa górna część orurowania / Right upper attachments / Правая, верхняя часть защиты / Rechte, obere Seite des Frontschutzbügels

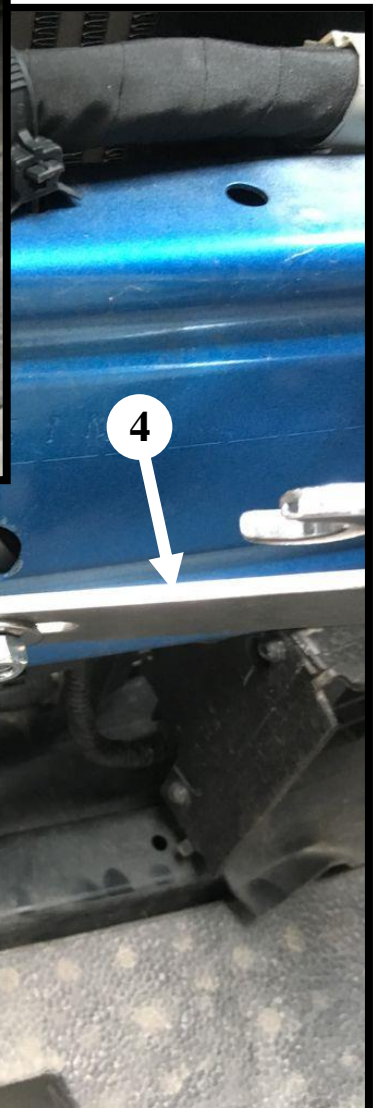
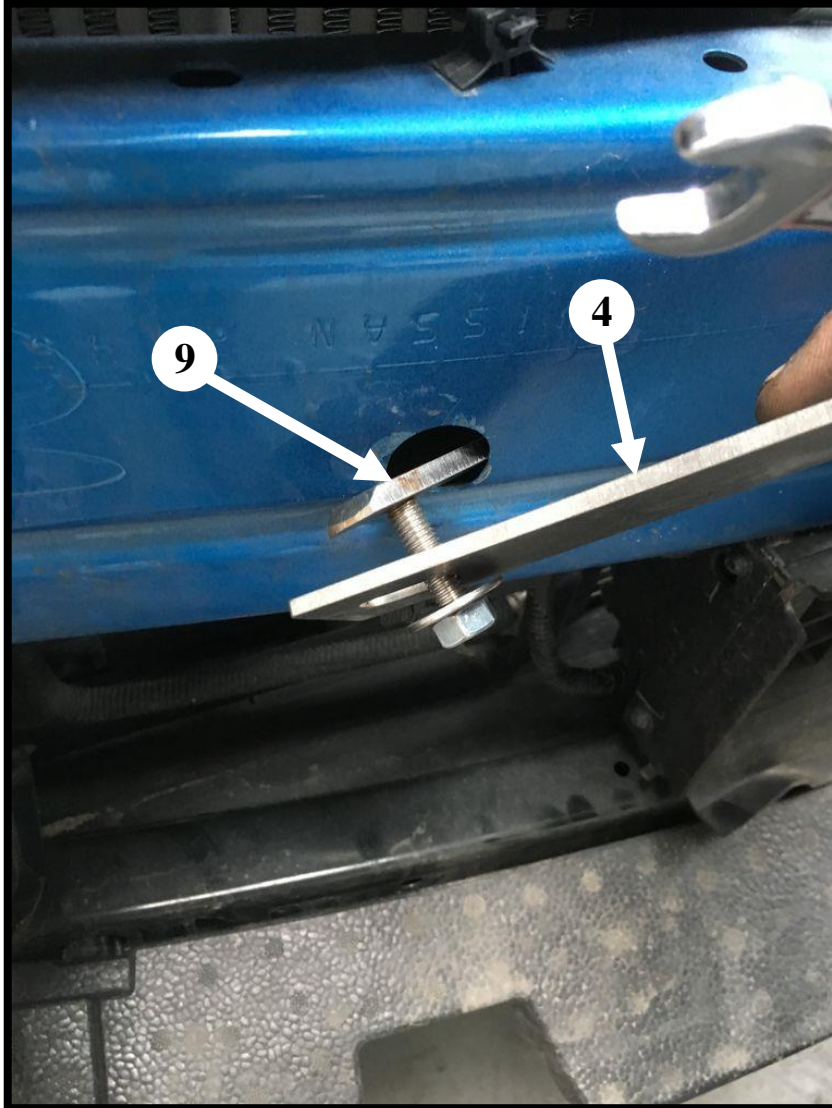

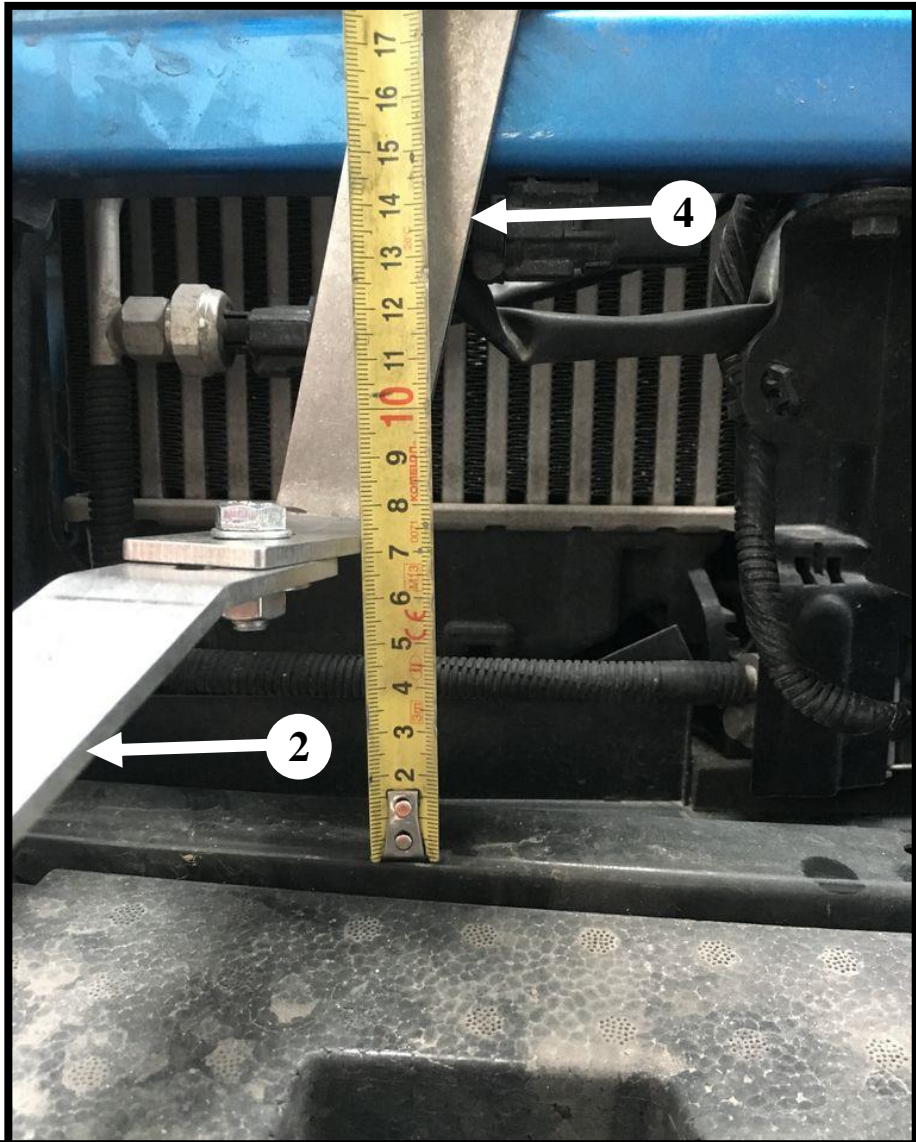

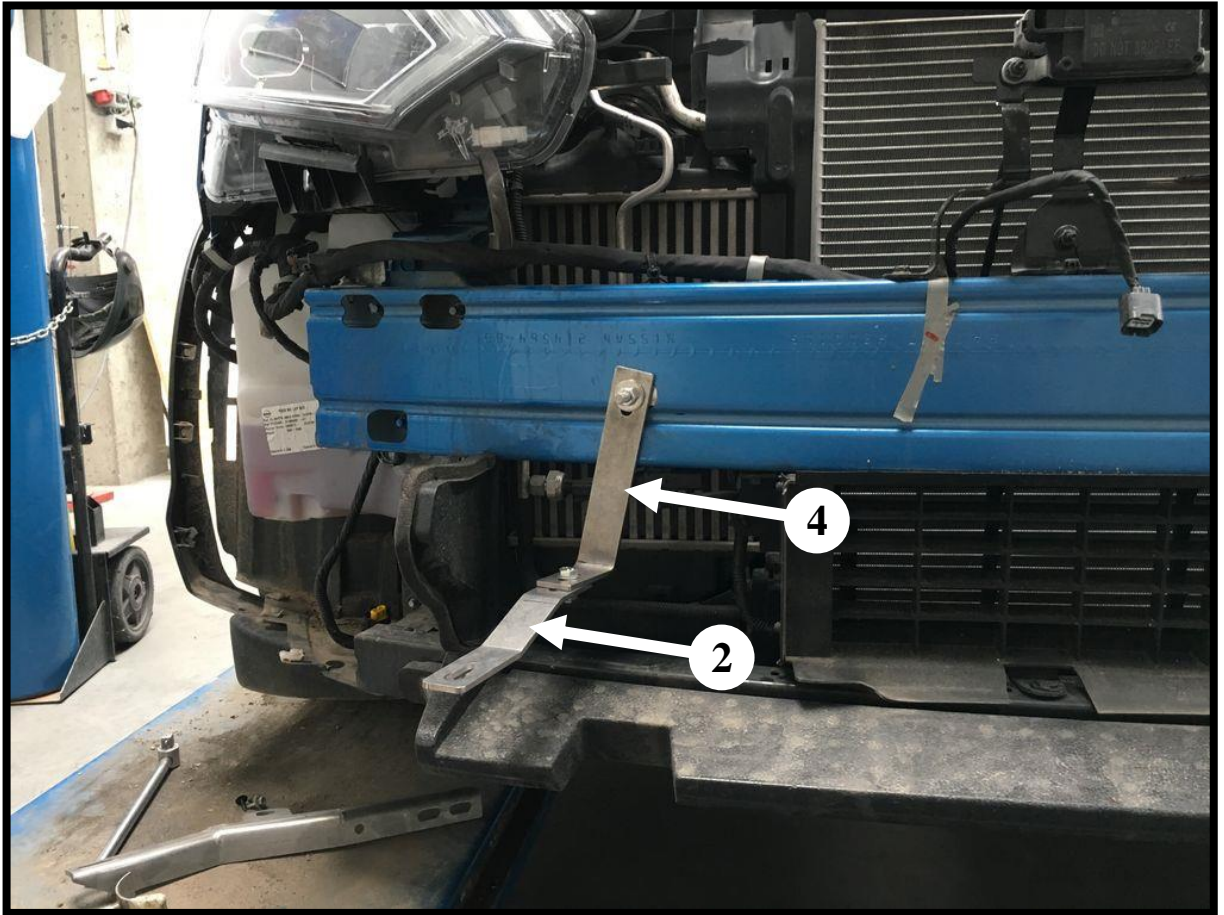
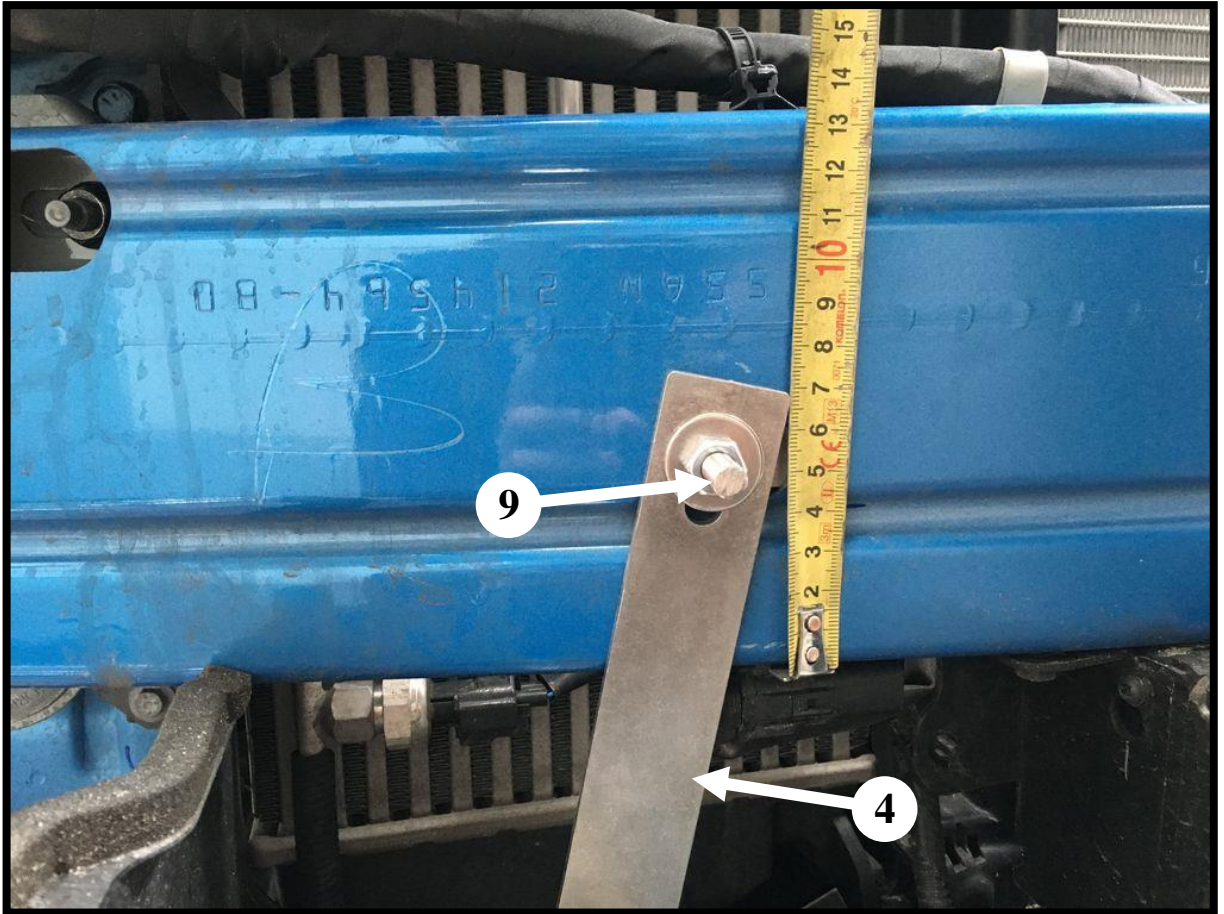

Lewa dolna część orurowania / Left, lower attachments / Левая, нижняя часть защиты / Linke, untere Seite des Frontschutzbügels

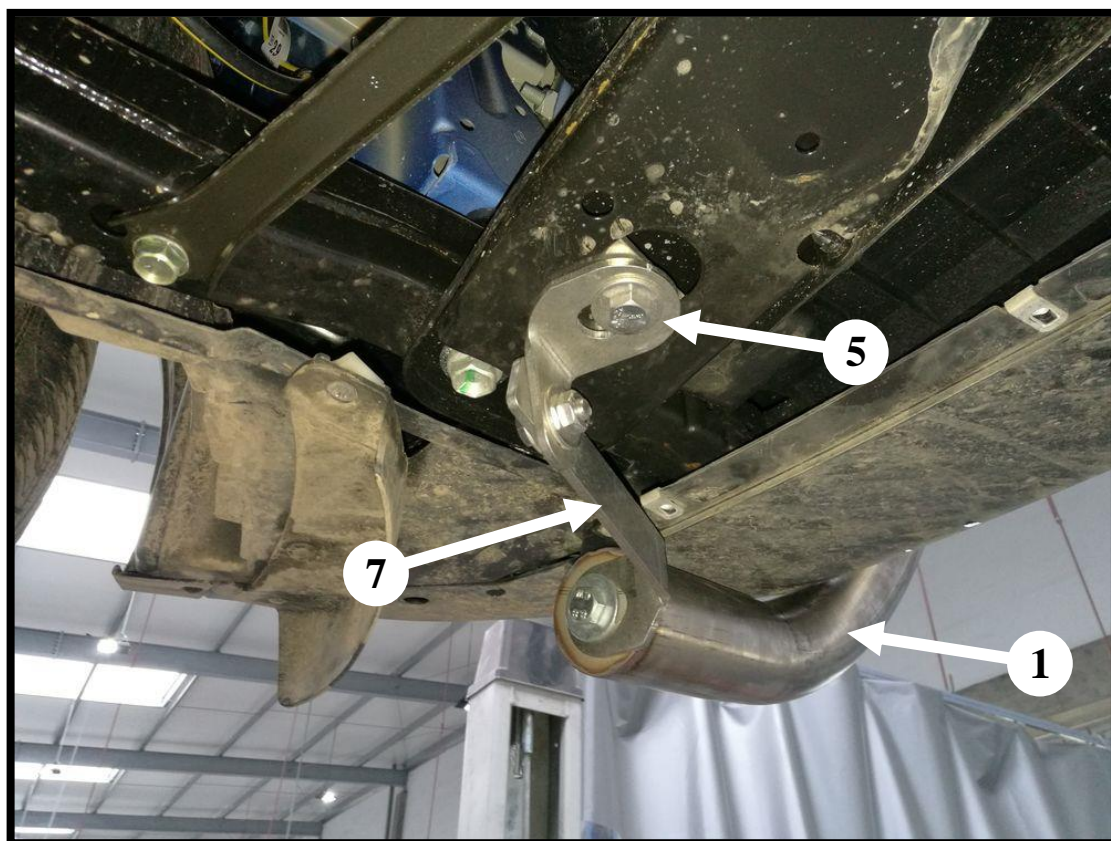
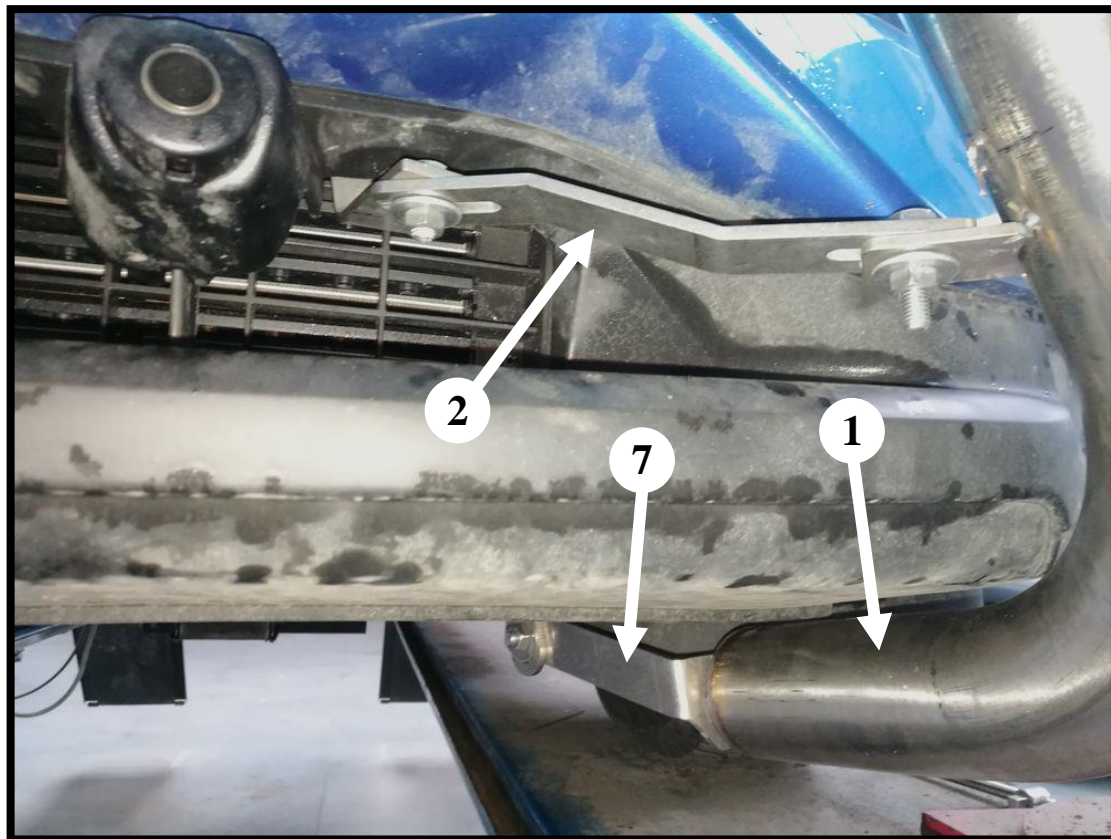
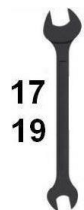

Prawa dolna część orurowania / Lower right attachments / Правая, нижняя часть защиты / Rechte, untere Seite des Frontschutzbügels

