

MISUBONIDA
italian style
accessories 4x4



EC Type Approval Certificate
Certificato d'omologazione Europea
Certifié d'homologation Européenne

EC Approved Ø 63mm Frontal System
Protezione Anteriore Ø 63mm Omologata
Protection Antérieure Ø 63mm Homologuée
for/per/pour

VOLKSWAGEN TIGUAN
Mod.2016

PART EC/MED/409/IX

type approval n.
n. di omologazione
numero d'homologation
e9*78/2009*459/2011B*1153*00



Approval sign
Codice di omologazione
Code d'homologation

B e9 02 1153 Type409



e9*78/2009*459/2011B*1153*00

Página / Page 1/4

Comunicación relativa a / *Communication concerning the*

- homologación CE / *EC type-approval* (1)
- ~~extensión de la homologación CE / *extension of EC type-approval* (1)~~
- ~~denegación de homologación CE / *refusal of EC type-approval* (1)~~
- ~~retirada de homologación CE / *withdrawal of EC type-approval* (1)~~

respecto a un sistema de protección delantera que deba administrarse como unidad técnica independiente / *of a type of frontal protection system to be supplied as a separate technical unit*

De conformidad con el reglamento (CE) nº 78/2009 del Parlamento Europeo y del Consejo, de 14 de enero de 2009, aplicado por / *with regard to Regulation (EC) No 78/2009 of the European Parliament and of the Council of 14 January 2009 as implemented by*

Y modificado por última vez por el Reglamento (CE) nº / *last amended by Regulation (EC) No 631/2009(2)*

Nº de homologación / *Type approval number*: e9*78/2009*459/2011B*1153*00

SECCIÓN I / SECTION I

- 0.1. Marca (razón social del fabricante) / *Make (trade name of manufacturer)*: MISUTONIDA
- 0.2. Tipo / *Type*: 409
- 0.3. Medio de identificación del tipo de vehículo, si está marcado en este / *Means of identification of type, if marked on the vehicle (3)*: Ver documentación aportada por el fabricante / *See technical documentation supplied by the manufacturer.*
- 0.3.1. Ubicación de esa marca / *Location of that marking*: Ver documentación aportada por el fabricante / *See technical documentation supplied by the manufacturer*
- 0.5. Nombre o razón social y domicilio del fabricante / *Name and address of manufacturer*:
MACH, S.R.L.
Via Fondovalle 3
12062 CHERASCO (CN)
ITALIA
- 0.7. Emplazamiento y forma de colocación de la marca de homologación CE / *Location and method of affixing of the EC type-approval mark*: Ver documentación aportada por el fabricante / *See technical documentation supplied by the manufacturer.*

- 0.8. Nombre(s) y dirección(es) de la(s) planta(s) de montaje / *Names and address(es) of assembly plant(s)*:

MACH, S.R.L.
Via Fondovalle 3
12062 CHERASCO (CN)
ITALIA

(1) Táchese lo que no proceda / *Delete where not applicable*

(2) Insértese el número de Reglamento modificador / *Insert number of amending Regulation*

(3) Si el medio de identificación del tipo contiene caracteres no pertinentes para la descripción del vehículo, la unidad técnica independiente o el componente a que se refiere esta información, tales caracteres se sustituirán en el documento por el símbolo «?». / *If the means of identification of type contains characters not relevant to describe the vehicle, component or separate technical documentation unit types covered by this information, such characters shall be represented in the documentation by the symbol «?».*



e9*78.2009*459/2011B*1153*00

Página / Page 3/4

Adenda al certificado de homologación CE nº e9*78/2009*459/2011B*1153*00 sobre la homologación de un vehículo en lo referente a la protección de los peatones conforme al Reglamento (CE) nº 78/2009 *Addendum to EC type-approval certificate No e9*78.2009*459/2011B*1153*00 concerning the type-approval of a vehicle with regard to pedestrian protection with regard to Regulation (EC) No 78/2009*

1. Información adicional / Additional information

- 1.1. Método de acoplamiento / Method of attachment: Mediante tornillos / With screws.
- 1.2. Instrucciones de montaje e instalación / Assembly and mounting instructions: Ver documentación aportada por el fabricante / See technical documentation supplied by the manufacturer.
- 1.3. Lista de tipos de vehículos en los que se puede instalar el sistema, restricciones de uso y condiciones para el montaje. / List of vehicles on which the frontal protection system may be fitted, any usage restrictions and necessary conditions for fitting:

Tipo de vehículo / Type of vehicle	Denominación comercial / Commercial description	Contraseña de homologación / Approval number
5N	VOLKSWAGEN TIGUAN 2016	e1*2001/116*0450*..

- 2. Observaciones / Remarks:---

- (1) Táchese lo que no proceda / Delete where not applicable
- (2) Insértese el número de Reglamento modificador / Insert number of amending Regulation
- (3) Si el medio de identificación del tipo contiene caracteres no pertinentes para la descripción del vehículo, la unidad técnica independiente o el componente a que se refiere esta información, tales caracteres se sustituirán en el documento por el símbolo "x". / If the means of identification of type contains characters not relevant to describe the vehicle, component or separate technical documentation unit types covered by this information, such characters shall be represented in the documentation by the symbol "x".



e9*78/2009*459/2011B*1153*00

Página / Page 4/4

3. Resultados de los ensayos con arreglo a los requisitos del anexo I, sección 5, del Reglamento (CE) nº 78/2009 / Test results according to the requirements of Section 5 of Annex I to Regulation (EC) No 78/2009

Ensayo / Test	Valores registrados / Values recorded		Superado/Pass / No superado/fail
Parte inferior de la pierna-sistema de protección delantera / lower legform to frontal protection system 3 posiciones de ensayo / 3 test positions (en su caso) / (where performed)	Ángulo de flexión / Bending angle	SB: 2.21 grados/degrees 1.35 grados/degrees 12.18 grados/negrees MED: 2.15 grados/negrees 2.32 grados/negrees 8.74 grados/negrees	Superado/Pass
	Desplazamiento de rotura / Shear displacement	SB: 4.41 mm 3.66 mm 3.36 mm MED: 3.05 mm 2.52 mm 2.49 mm	Superado/Pass
	Acceleración en tibia / Acceleration at tibia	SB: 112.24 g 88.12 g 146.29 g MED: 136.58 g 124.10 g 126.02 g	Superado/Pass
Parte superior de la pierna-Sistema de protección delantera / Upper legform to frontal protection system 3 posiciones de ensayo / 3 test positions (en su caso) / (where performed)	Suma de las fuerzas de impacto / Sum of impact forces	kN	No procede / does not apply
	Momento de flexión / Bending moment	Nm	No procede / does not apply
Parte superior de la pierna-sistema de protección delantera borde delantero / Upper legform to frontal protection system leading edge 3 posiciones de ensayo / 3 test positions (solo observación) / (monitoring only)	Suma de las fuerzas de impacto / Sum of impact forces	kN kN	solo observación / monitoring only
	Momento de flexión / Bending moment	Nm Nm	solo observación / monitoring only
Cabeza de niño / de adulto de pequeño tamaño (3,5 kg)-Sistema de protección delantera / Child small adult headform (3,5 kg) to frontal protection system	Valores HPC (al menos 3 valores) / HPC values (at least 3 values)	---	No procede / does not apply

- (1) Táchese lo que no proceda / Delete where not applicable
- (2) Insértese el número de Reglamento modificador / Insert number of amending Regulation
- (3) Si el medio de identificación del tipo contiene caracteres no pertinentes para la descripción del vehículo, la unidad técnica independiente o el componente a que se refiere esta información, tales caracteres se sustituirán en el documento por el símbolo '?' / If the means of identification of type contains characters not relevant to describe the vehicle, component or separate technical documentation unit types covered by this information, such characters shall be represented in the documentation by the symbol '?'.

MISUTONIDA
 italian style
 accessories **4x4**

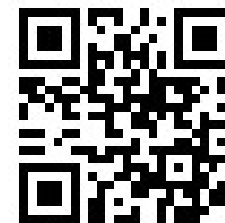

VOLKSWAGEN TIGUAN 2016



40 Min.

Item Code

Codice Articolo

: EC/MED/409/IX

Référence Article

GB

STAINLESS STEEL
 MEDIUM BAR

ITA















MEDIUM BAR
 IN ACCIAIO INOX

FR

MEDIUM BAR
 EN ACCIER INOX

VOLKSWAGEN TIGUAN 2016

Part List
Lista della bulloneria
Liste des pièces

A  TE M8X20 x 4	B  Ø 8 x 4	C  Ø 8 x 4	D  TE M6X40 x 2	E  TE M6X25 x 4
F  Ø 6 BIG GRANDE GRAND x 6	G  Ø 6 x 6	H  M 6 x 4	I  145 x 2	L  SM/409/A x 2
M  SM/409/B x 1	N  SM/409/C x 2	 Cappelletti M8	 STICKERS PARK SENSOR x 2	

Place the stickers on the central park sensors
Applicare gli stickers sui due sensori di parcheggio centrali
Appliquer les stickers sûr les park sensors centrales

*lubricate the set of bolts
supplied before tightening
them*



*Si consiglia di lubrificare
la bulloneria in dotazione
prima del serraggio*

*Lubrifier la boulonnerie fournie
avant de la serrer*

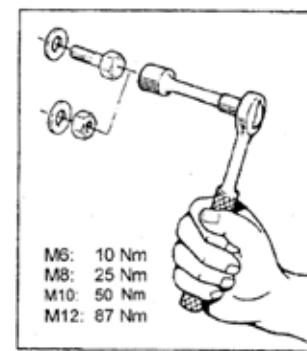

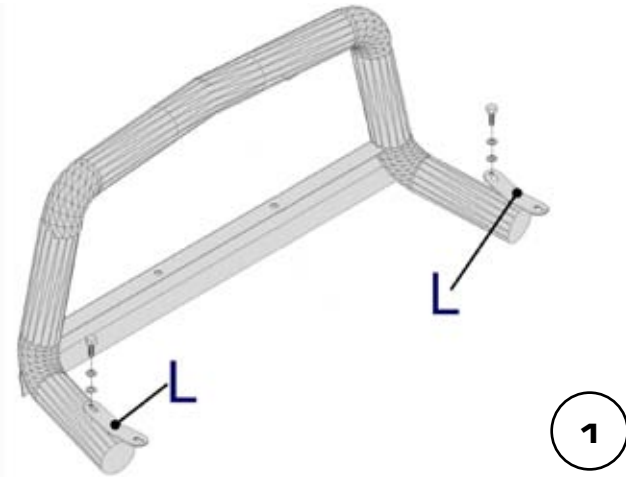

Date Data Date	Item Code Cod.Articolo Réf. Article	Vehicle model Modello Veicolo Modèle de Voiture
30/11/16	EC/MED/409/IX	VOLKSWAGEN TIGUAN 2016

MISUTONIDA
italian style accessories **4x4**

Document checked and approved by
Documento controllato ed approvato da
Document contrôlé et approuvé par

**Botta
Pietro**



7



8



9



10



11



12

Date Data Date	Item Code Cod.Articolo Réf. Article	Vehicle model Modello Veicolo Modèle de Voiture
30/11/16	EC/MED/409/IX	VOLKSWAGEN TIGUAN 2016

Document checked and approved by
Documento controllato ed approvato da
 Document contrôlé et approuvé par

Botta
Pietro



13



14

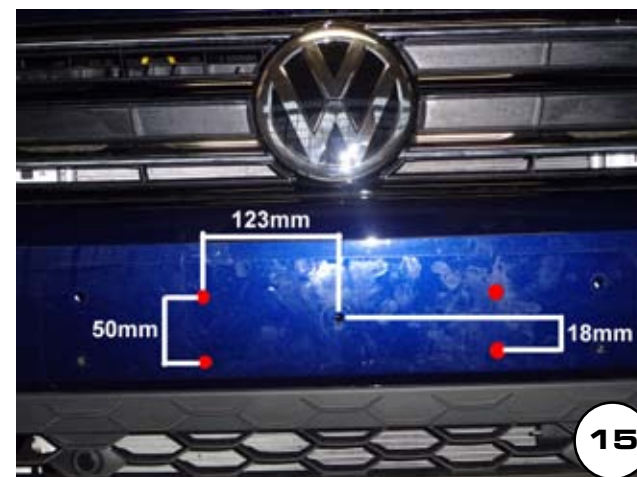

15



16



17



18

Date Data Date	Item Code Cod.Articolo Réf. Article	Vehicle model Modello Veicolo Modèle de Voiture
30/11/16	EC/MED/409/IX	VOLKSWAGEN TIGUAN 2016

Document checked and approved by
Documento controllato ed approvato da
Document contrôlé et approuvé par

Botta
Pietro



Date Data <i>Date</i>	Item Code Cod.Articolo <i>Réf. Article</i>	Vehicle model Modello Veicolo <i>Modèle de Voiture</i>
30/11/16	EC/MED/409/IX	VOLKSWAGEN TIGUAN 2016

Document checked and approved by
Documento controllato ed approvato da
Document contrôlé et approuvé par

Botta
Pietro